

INTERROLL DRUM MOTOR 113S



Standard
Asynchronous
Drum Motors
113S

Compact drive for light-duty conveyors

Product Description

Applications

The drum motor is a perfect drive station for small and medium-duty conveyor systems.

- ✓ Light-duty conveyors
- ✓ Packaging equipment
- ✓ Bottle recycling
- ✓ X-ray security scanning systems
- ✓ Pharmaceutical handling
- ✓ Dry and moist applications

Characteristics

- ✓ 3-phase or 1-phase AC induction motor
- ✓ Single-rated voltage
- ✓ Integral thermal motor protection
- ✓ Technopolymer planetary gearbox
- ✓ Low noise
- ✓ Lightweight
- ✓ Maintenance-free (with aluminium shaft caps)
- ✓ Lifetime lubricated
- ✓ Reversible

Technical Data

Electrical data

Motor type	Asynchronous squirrel cage motor, IEC 34 (VDE 0530)
Insulation class of motor windings	Class F, IEC 34 (VDE 0530)
Voltage	230/400 V ±5 % (IEC 34/38)
Frequency	50 Hz
Internal shaft sealing system	Double-lipped, NBR
External shaft sealing system	Deflection seal, NBR
Protection rate	IP66 (with grease nipple)
Thermal protection (see p 245)	Bi-metal switch
Operating modes (see p 230)	S1
Ambient temperature, 3-phase motor (see p 207)	+5 to +40 °C
Ambient temperature, 1-phase motor (see p 207)	+5 to +40 °C

General technical data

Max. shell length SL	1,090 mm
----------------------	----------

Order Information

Please refer to the Configurator at the end of the catalogue..

Material Versions

You can choose the following versions of drum body components and electrical connection. The versions depend on the material of the components.

Component	Version	Material			
		Aluminium	Mild steel	Stainless steel	Brass / Nickel
Shell	Crowned		✓	✓	
	Cylindrical		✓	✓	
End housing	Standard	✓		✓	
Shaft cap	Standard	✓			
	With cable protection	✓			
	Regreasable			✓	
Electrical connector	Straight connector			✓	✓
	Elbow connector			✓	
	Terminal box	✓		✓	

Please contact your Interroll customer consultant for further versions.

Options

- Lagging for friction drive belts, see p 128
- Food-grade oil (EU, FDA), see p 256
- Low temperature oil, see p 256
- cULus safety certifications, see p 251
- Non-horizontal mounting (more than ± 5°), see p 231

Accessories

- Mounting brackets, see p 164
- Idler pulleys, see p 178 to p 183
- Conveyor rollers, see p 188
- IFI - IP55 Frequency Inverter, see p 122

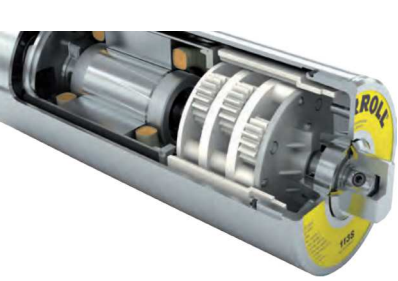

INTERROLL DRUM MOTOR 113S



Standard
Asynchronous
Drum Motors
113S

Compact drive for light-duty conveyors

Product Range

The following tables give an overview of the possible motor versions. When ordering, please specify the version in accordance with the configurator at the end of the catalogue.

All data and values in this catalogue refer to 50 Hz operation.

Motor versions

Mechanical data for 3-phase motors

P_N kW	np	gs	i	v m/s	n_A min ⁻¹	M_A Nm	F_N N	SL_{min} mm
0.040	8	3	63.00	0.068	11.4	28.6	505	260
			49.29	0.087	14.6	22.4	395	260
			38.51	0.111	18.7	17.5	309	260
0.110	4	3	63.00	0.129	21.7	41.6	734	240
			49.29	0.164	27.7	32.5	574	240
			44.09	0.184	31.0	29.1	514	240
			38.51	0.210	35.4	25.4	449	240
			30.77	0.263	44.4	20.3	359	240
			26.84	0.302	50.9	17.7	313	240
	2	23.96	0.338	57.0	15.8	279	240	
		15.00	0.540	91.0	10.4	184	240	
		11.57	0.700	118.0	8.0	142	240	
		10.27	0.788	132.9	7.1	126	240	
		8.88	0.912	153.8	6.2	109	240	
		7.86	1.031	173.7	5.5	96	240	
0.160	4	3	44.09	0.182	30.6	42.7	754	260
0.180	4	3	38.51	0.209	35.2	41.9	740	275
			30.77	0.261	44.0	33.5	591	275
			26.84	0.300	50.5	29.2	516	275
			23.96	0.335	56.6	26.1	461	275
			15.00	0.536	90.3	17.2	303	275
			11.57	0.695	117.1	13.3	234	275
	2	10.27	0.782	131.9	11.8	208	275	
		8.88	0.905	152.6	10.2	180	275	
		7.86	1.023	172.5	9.0	159	275	
		44.09	0.377	63.5	42.7	754	275	
		38.51	0.431	72.7	37.3	659	275	
		30.77	0.540	91.0	29.8	526	275	
0.330	2	3	26.84	0.619	104.3	26.0	459	275
			23.96	0.693	116.9	23.2	410	275
			15.00	1.107	186.7	15.3	270	275

Mechanical data for 1-phase motors

P_N kW	np	gs	i	v m/s	n_A min ⁻¹	M_A Nm	F_N N	SL_{min} mm			
0.060	4	3	63.00	0.122	20.6	23.8	420	240			
			49.29	0.156	26.4	18.6	328	240			
			44.09	0.175	29.5	16.6	294	240			
			38.51	0.200	33.8	14.5	256	240			
			30.77	0.251	42.3	11.6	205	240			
			26.84	0.287	48.4	10.1	179	240			
		2	23.96	0.322	54.3	9.0	160	240			
			15.00	0.514	86.7	6.0	105	240			
			0.080	6	2	15.00	0.352	59.3	11.6	206	275
			11.57			0.456	76.9	9.0	159	275	
			0.110	4	3	63.00	0.122	20.6	43.8	772	260
						49.29	0.156	26.4	34.2	604	260
44.09	0.175	29.5				30.6	541	260			
38.51	0.200	33.8				26.7	472	260			
30.77	0.251	42.3				21.4	377	260			
26.84	0.287	48.4				18.6	329	260			
2	23.96	0.322			54.3	16.6	294	260			
	15.00	0.514			86.7	11.0	194	260			
	11.57	0.666			112.3	8.5	149	260			

P_N	Rated power
np	Number of poles
gs	Gear stages
i	Gear ratio
v	Rated velocity of the shell
n_A	Rated revolutions of the drum shell
M_A	Rated torque of drum motor
F_N	Rated belt pull of drum motor
SL_{min}	Min. shell length

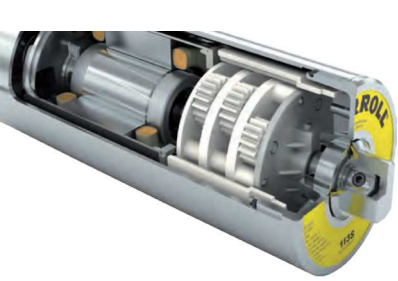

INTERROLL DRUM MOTOR 113S



Standard
Asynchronous
Drum Motors
113S

Compact drive for light-duty conveyors

Belt Tension

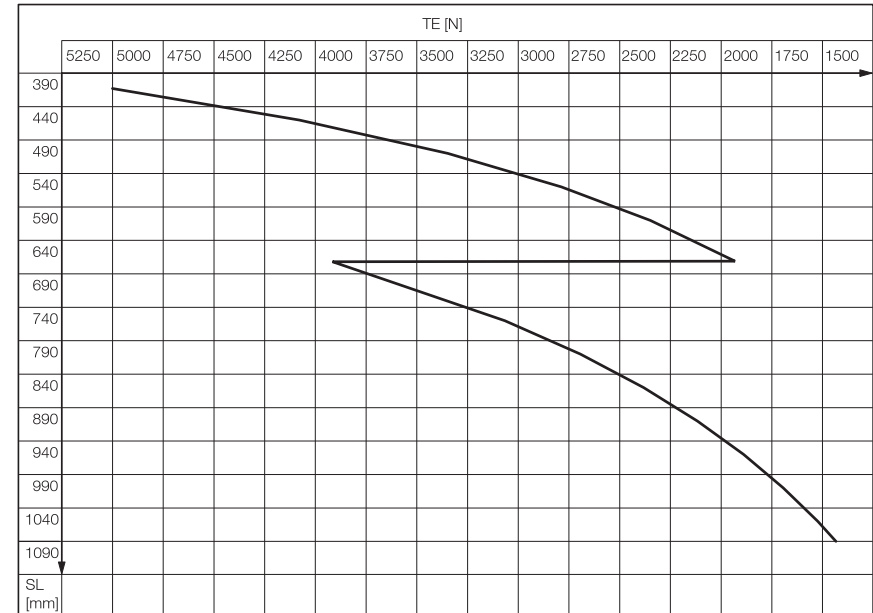
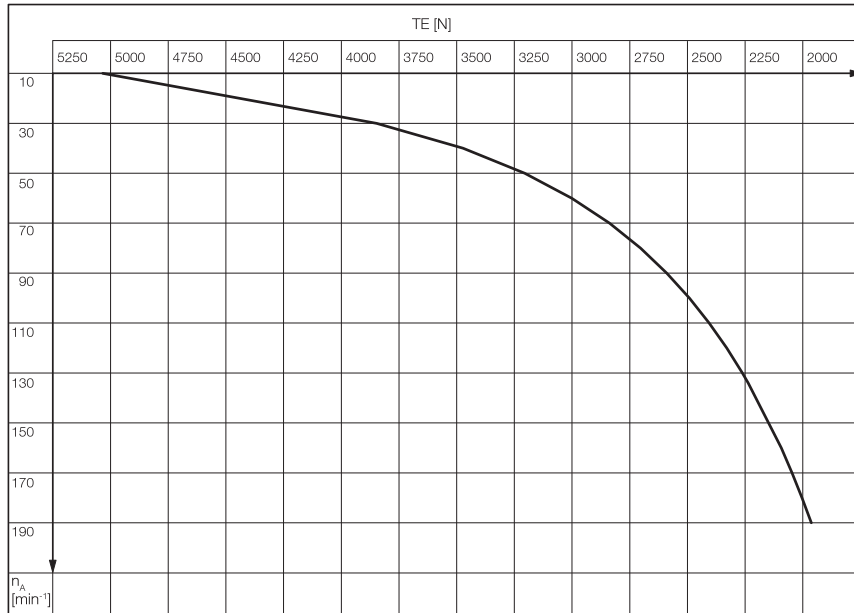

Note: To get the right value of the maximum allowed belt tension, first find the maximum allowed TE value for the drum motor RPM. For motors with SL > 400 mm, check if the maximum allowed TE value for the SL is lower. In this case, use the lower value as maximum allowed TE value.

TE	Belt Tension
n_A	Rated revolutions of the drum shell
SL	Shell length

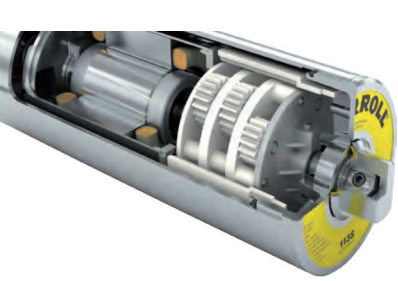

INTERROLL DRUM MOTOR 113S



Standard
Asynchronous
Drum Motors
113S

Compact drive for light-duty conveyors

Electrical data for 3-phase motors

P_N kW	np	U_N V	I_N A	cos φ	η	J_R kgcm ²	I_s/I_N	M_s/M_N	M_p/M_N	M_B/M_N	R_M Ω	$U_{SH \text{ delta}}$ V DC	$U_{SH \text{ star}}$ V DC
0.040	8	230	0.64	0.58	0.27	3.9	1.5	1.59	1.49	1.59	187.5	35	-
		400	0.37	0.58	0.27	3.9	1.5	1.59	1.49	1.59	187.5	-	60
0.110	4	230	0.80	0.73	0.47	2.3	3.6	3.38	3.38	3.39	84.0	25	-
		400	0.45	0.75	0.47	2.3	3.6	3.41	3.41	3.42	84.0	-	43
0.160	4	230	0.98	0.76	0.54	3.3	4.0	3.22	3.22	3.33	59.2	22	-
		400	0.57	0.75	0.54	3.3	4.0	3.25	3.25	3.35	59.2	-	38
0.180	4	230	1.00	0.77	0.59	4.0	4.4	3.54	3.54	3.74	45.5	18	-
		400	0.62	0.76	0.55	4.0	4.4	3.60	3.60	3.79	45.5	-	32
0.330	2	230	1.74	0.76	0.68	3.3	4.5	3.57	2.62	3.57	21.5	14	-
		400	0.93	0.76	0.68	3.3	4.5	3.57	2.62	3.57	21.5	-	23

Electrical data for 1-phase motors

P_N kW	np	U_N V	I_N A	cos φ	η	J_R kgcm ²	I_s/I_N	M_s/M_N	M_p/M_N	M_B/M_N	R_M Ω	$U_{SH \sim}$ V DC	C_r μF
0.060	4	230	0.74	0.98	0.36	2.3	2.6	1.29	1.29	2.60	63.5	35	4
0.080	6	230	1.35	0.99	0.26	4.0	1.9	0.70	0.70	1.65	45.9	46	8
0.110	4	230	1.13	0.88	0.48	3.2	2.9	1.06	1.06	2.31	32.5	24	6

P_N	Rated power
np	Number of poles
U_N	Rated voltage
I_N	Rated current
cos φ	Power factor
η	Efficiency
J_R	Rotor moment of inertia
I_s/I_N	Ratio of starting current to rated current
M_s/M_N	Ratio of starting torque to rated torque
M_p/M_N	Ratio of pull-up torque to rated torque
M_B/M_N	Ratio of break-down torque to rated torque
R_M	Phase resistance
$U_{SH \text{ delta}}$	Preheating voltage in delta connection
$U_{SH \text{ star}}$	Preheating voltage in star connection
U_{SH}	Preheating voltage in single phase
C_r	Capacitor size

Cable Specifications

Available cables for connectors (see also p 254):

- Standard, screened
- Standard, unscreened
- Halogen-free, screened
- Halogen-free, unscreened

Available length: 1 / 3 / 5 m

Note: Only single voltage available with Halogen-free, screened cables.

Connection Diagrams

For connection diagrams, see Planning Section on p 258.

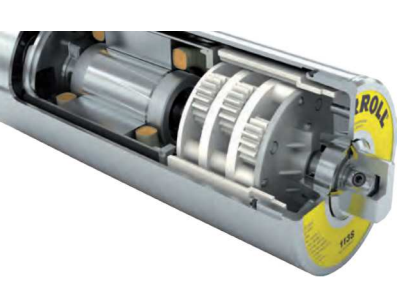

Standard
Asynchronous
Drum Motors
113S

INTERROLL DRUM MOTOR 113S

Compact drive for light-duty conveyors

Standard
dimensions

Dimensions

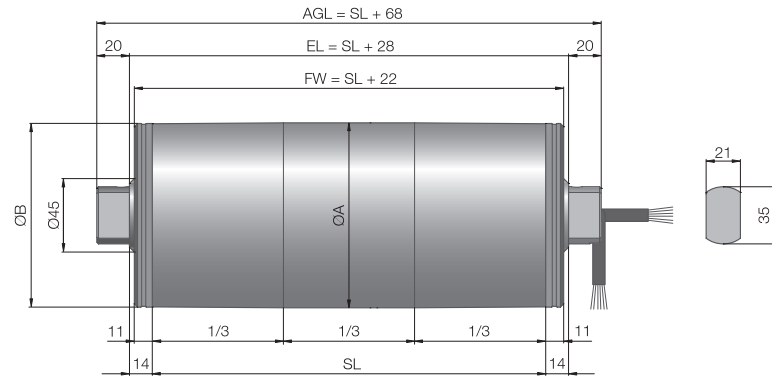

Fig.: Drum motor with shaft cap

Type	Ø A mm	Ø B mm
113S crowned shell	113.3	112.4
113S cylindrical shell	113.0	113.0

Connector
dimensions

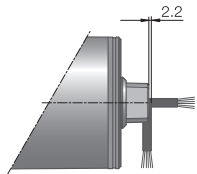

Fig.: Shaft cap, standard,
aluminium

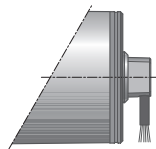

Fig.: Shaft cap with cable
protection, aluminium

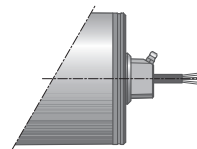

Fig.: Straight connector with
regreasable shaft cap,
stainless steel

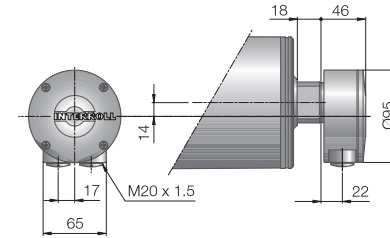

Fig.: Terminal box, aluminium

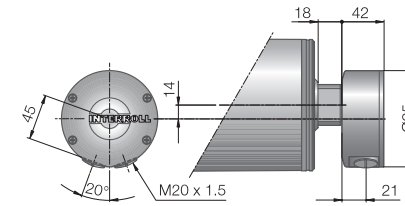

Fig.: Terminal box, stainless steel

Standard drum motor lengths and their weights:

	240	290	340	390	440	490	540	590	640	690	740	790	840
Shell length SL in mm	240	290	340	390	440	490	540	590	640	690	740	790	840
Average weight in kg	7.6	8.3	9	9.7	10.4	11.1	11.8	12.5	13.2	13.9	14.6	15.3	16
Shell length SL in mm	890	940	990	1,040	1,090								
Average weight in kg	16.7	17.4	18.1	18.8	19.5								

Standard length
and weight